

SKEMA®

Living

superior laminate floorings



Living

superior laminate floorings

 **Organica**

 **Patio**

 **Sonora**

 **Vertical**

 **Sistema**

PRODOTTO FABBRICATO IN PAESI U.E. / PRODUCED IN E.U. COUNTRIES

K-uno Hydro Plus	08
Syncro Parquet Hydro Plus	12
Prestige Gold Hydro	16
Prestige L Hydro	22
Facile +	26
Vision Oxid Hydro Plus	32
Vision Technic Hydro	36
Accessori Accessories	40
Tabella Logistica Logistics Data Table	52

Skema Superior Laminate Flooring

La linea Living di Skema nel 2024 porta il laminato ad un livello superiore, con collezioni riviste e potenziate ancora di più nelle qualità tecniche e quindi nelle prestazioni. Superior laminate flooring perché sono prodotti progettati per essere posati in tutti i tipi di contesti, residenziali e pubblici, resistendo ad usura, alto calpestio (AC4-AC5-AC6) e ristagni d'acqua (tecnologia Hydro e Hydro Plus), al contempo forniscono grande praticità di pulizia (antistatici e antibatterici) e di posa (con incastri innovativi come il nuovo 5G Dry), e grande versatilità. Superior laminate flooring perché sono rivestimenti realizzati al 100% con legno sostenibile e certificato PEFC, certificati, capaci di superare tutti i test e rientrare nei parametri CAM, resistenti al fuoco e salubri (con classe A+).

Superior laminate flooring perché, grazie ai tanti formati disponibili, ai decori di tendenza che spaziano dall'effetto legno a quello pietra e agli spessori ridotti, permettono di progettare con stile e grande facilità nuovi ambienti e ristrutturazioni su pavimenti esistenti come casa, uffici, negozi, spazi collettivi, bagni.

Skema's Living line in 2024 takes laminate flooring to the next level, with collections revised and enhanced even more in technical qualities and thus performance. Superior laminate flooring because they are products designed to be laid in all kinds of contexts, residential and public, resisting wear, high footfall (AC4-AC5-AC6) and water stagnation (Hydro and Hydro Plus technology), while providing great practicality cleaning (anti-static and antibacterial) and laying (with innovative joints such as the new 5G Dry), and great versatility. Superior laminate flooring because they are cladding made from 100% sustainable and PEFC-certified wood, certified, able to pass all tests and fall within CAM parameters, fire-resistant and healthy (with class A+). Superior laminate flooring because, thanks to the many available formats, trendy decors ranging from wood to stone effect, and reduced thicknesses, they make it possible to design with style and great ease new environments and renovations on existing floors like home, offices, stores, collective spaces, bathrooms.

PrestigeL
Hydro
Alpaca
Oak

Pavimenti in laminato **resistenti** all'acqua

Nel 2024 Skema rinforza la proposta prestazionale rendendo tutte le collezioni di laminato Living resistenti all'acqua e migliorando con un upgrade i prodotti di punta. Prestige Gold e il nuovo Vision Technic si potenziano con la tecnologia Hydro standard (4 ore di protezione), anche Prestige L diventa Hydro con in più l'incastro 5g Dry ad alta tenuta meccanica, che ne migliora le performance, semplifica la posa e migliora l'impermeabilità del incastro. Un sistema che troviamo anche nel rinnovo della collezione K-Uno che in più viene dotato della nuova tecnologia Hydro Plus per resistere ulteriormente ai ristagni d'acqua, fino a 24 ore, grazie allo speciale trattamento del profilo dell'incastro. Oltre a K-Uno Hydro Plus, troviamo altre due collezioni potenziate nella resistenza all'acqua: Syncro Parquet Hydro Plus e Vision Oxid Hydro Plus così tutta l'offerta estetica, effetto legno, spina di pesce e decorativi materici, sono oggi disponibili in una versione ancora più performante e ancora più resistente, ideali per la posa in bagni, spogliatoi e tutti gli ambienti dove si fa largo uso dell'acqua.

In 2024, Skema reinforces its performance proposition by making all Living laminate collections water-resistant and upgrading its flagship products with an upgrade. Prestige Gold and the new Vision Technic are upgraded with standard Hydro technology (4 hours of protection), also Prestige L becomes Hydro with in addition the 5g Dry interlocking with high mechanical seal, which improves its performance, simplifies installation and improves the waterproofing of the joint. A joint that we also find in the renewal of the K-Uno collection, which additionally comes with the new Hydro Plus technology to resist water stagnation even more, up to 24 hours, thanks to the special treatment of the joint profile. In addition to K-Uno Hydro Plus, we find two other collections enhanced in water resistance: Syncro Parquet Hydro Plus and Vision Oxid Hydro Plus so all the aesthetic offerings, wood effect, herringbone and textured decors, are now available in an even better performing and even more resistant version, ideal for installation in bathrooms, locker rooms and all environments where water is used extensively.

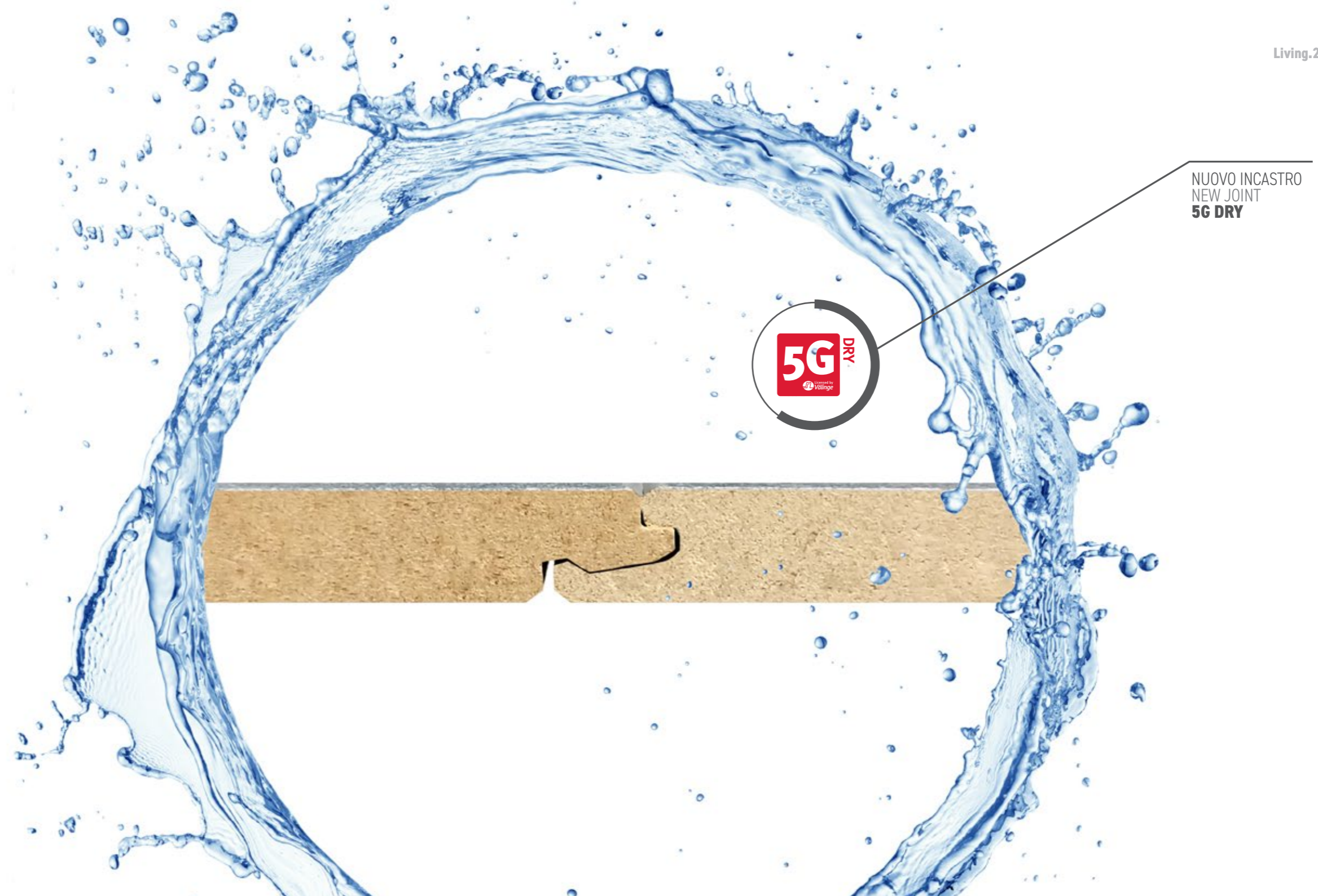

NUOVO INCASTRO
NEW JOINT
5G DRY

K-uno
HydroPlus
Rovere
Mexico



line Living **K-uno**HydroPlus

K-Uno Hydro Plus, unisce la nuova tecnologia Hydro Plus, che protegge la doga dai ristagni d'acqua per **24 ore**, al grande formato (2052x248x10mm) e alla superficie dotata di sincroporo, che conferisce un effetto ultra realistico al decorativo legno. La microbisellatura, protetta con componente Acquastop che la rende idro protetta, è presente sui 4 lati. **K-Uno Hydro** è dotato anche del nuovo incastro **5G Dry** che unisce a facilità e rapidità di posa la tenuta stagna del incastro.

K-Uno Hydro Plus, combines the new Hydro Plus technology, which protects the plank from water stagnation for 24 hours, with the large format (2052x248x10mm) and the surface equipped with syncropore, which gives an ultra-realistic effect to the decorative wood. Micro-beveling, protected with Acquastop component that makes it hydro-protected, is present on all 4 sides. **K-Uno Hydro** also features the new **5G Dry** joint that combines ease and speed of installation with watertightness of the joint.



INFO PRODOTTO
PRODUCT INFO

K-uno HydroPlus Rovere California

K-uno Hydro Plus - 5Gdry

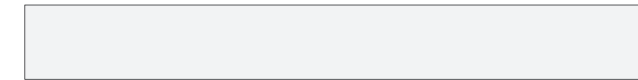

2052 x 248 x 10 mm

Info:

Incastro joint		5G Dry NEW
Bisello bevel		
Reazione al Fuoco * Fire reaction *		Cfl-s1
Riscaldamento a pavimento Suitable for radiant heating		Adatto Suitable
Comportamento Elettrico Static Electrical Behaviour		Antistatico Antistatic
Idoneo ad ambienti umidi Suitable For wet Environments		
Domestico Residential		23
Commerciale Commercial		32
Resistenza all'abrasione Abrasion resistance		

* Classificazione valida con l'utilizzo dei sottopavimenti e/o modalità indicate da Skema S.p.A. (per dettagli vedi scheda tecnica del prodotto e/o istruzioni per l'installazione).
* Classification valid with the use of underlayer and/or modality specified by Skema S.p.A. (please see product technical data sheet and/or installation instructions for details).

Certificazioni / Certifications:



Accessori / Accessories:

Sottopavimenti Underlayer	Superior RBR
Profilo Profile	Kit Dislivello + Dilatazione + Terminale + Toro scala Elite Splice Kit + Expansion Kit + Terminal Kit + Elite Stair noise
Battiscopa Skirting Board	Drop

Confezionamento / Packaging:

Rif. formato/Size	Pz/Pcs	m ²	Confezione/Box	m ²
2052x248	4	2,035	42	85,494

K-uno Hydro Plus - 5Gdry



520 Rovere Indiana
Emotion Finishing



527 Rovere Latino
Emotion Finishing



528 Rovere Texas
Emotion Finishing



530 Rovere Arizona
Emotion Finishing



531 Rovere Colorado
Emotion Finishing

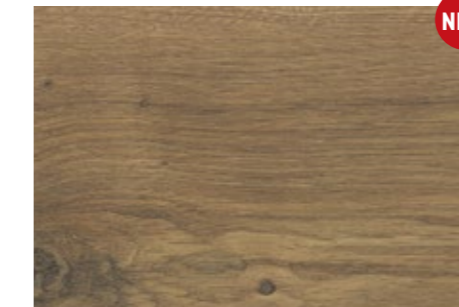

532 Rovere Mexico
Emotion Finishing

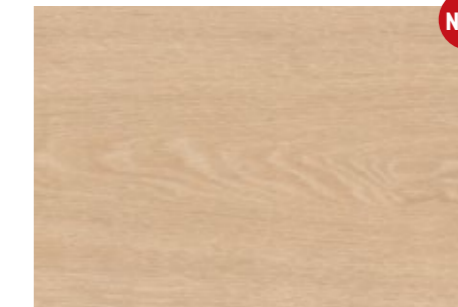

533 Rovere Yosemite
Emotion Finishing



534 Rovere Kansas
Emotion Finishing

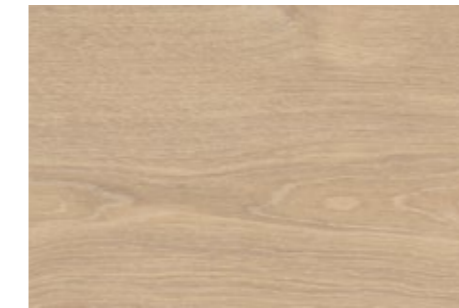

535 Rovere California New
Emotion Finishing



Book Finiture
Finishing Book



line Living
SyncroParquet
 HydroPlus

Syncro Parquet Hydro Plus permette di riscoprire l'eleganza del passato della posa a Spina Pesce, con una installazione pratica e veloce. Proposta nella versione classica e in quella ungherese, con taglio inclinato, idroprotetta ai ristagni d'acqua con tecnologia Hydro Plus. Ha uno spessore di **8 mm**, l'incastro PLS e massima classe di resistenza all'abrasione **AC6**.

Syncro Parquet Hydro Plus makes it possible to rediscover the elegance of the past of herringbone laying, with a quick and practical installation. Offered in classic and Hungarian versions with a slanted cut, hydro-protected against water stagnation with Hydro Plus technology. It has a thickness of **8 mm**, PLS interlocking and maximum abrasion resistance class **AC6**.



INFO PRODOTTO
 PRODUCT INFO

Syncro Parquet
 Hydro Plus
Ungherese
Rovere Grigio

Syncro Parquet Hydro Plus

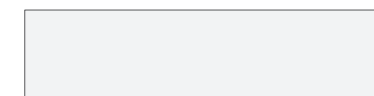

1184 x 293 x 8 mm UNGHERESE

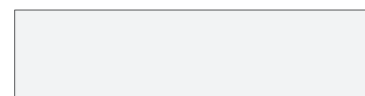

1182 x 293 x 8 mm CLASSICA

Info:

Incastro joint		PLS
Bisello bevel		SINCRO BISELLO STAMPATO SUI 4 LATI SYNCR BEVEL PRINTED ON THE 4 SIDES
Reazione al Fuoco * Fire reaction *		Bfl-s1
Riscaldamento a pavimento Suitable for radiant heating		Adatto Suitable
Comportamento Elettrico Static Electrical Behaviour		Antistatico Antistatic
Idoneo ad ambienti umidi Suitable For wet Environments		
Domestico Residential		23
Commerciale Commercial		33
Resistenza all'abrasione Abrasion resistance		

* Classificazione valida con l'utilizzo dei sottopavimenti e/o modalità indicate da Skema S.p.A. (per dettagli vedi scheda tecnica del prodotto e/o istruzioni per l'installazione).

* Classification valid with the use of underlayer and/or modality specified by Skema S.p.A. (please see product technical data sheet and/or installation instructions for details).

Certificazioni / Certifications:



Accessori / Accessories:

Sottopavimenti Underlayer	Superior RBR + DB + ST
Profilo Profile	Kit Distivello + Dilatazione + Terminale Splice Kit + Expansion Kit + Terminal Kit
Battiscopa Skirting Board	Star + Time + Look

Confezionamento / Packaging:

Rif. formato/Size	Pz/Pcs	m ²	Confezione/Box	m ²
1184x293	6	2,081	51	106,30
1182x293	6	2,078	51	106,02
CHATEAU ROVERE NATURALE				
11183x601	3	2,133	68	145,044

Syncro Parquet Hydro Plus

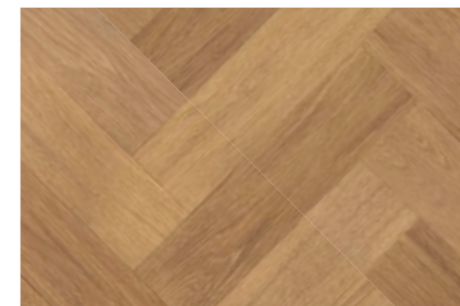

1150 Classica Rovere Naturale
Emotion Finishing

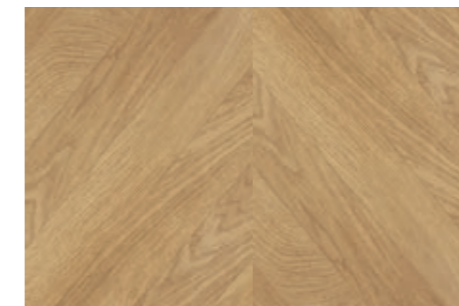

1151 Ungherese Rovere Naturale 30°
Emotion Finishing



1156 Ungherese Rovere Grigio 30°
Emotion Finishing

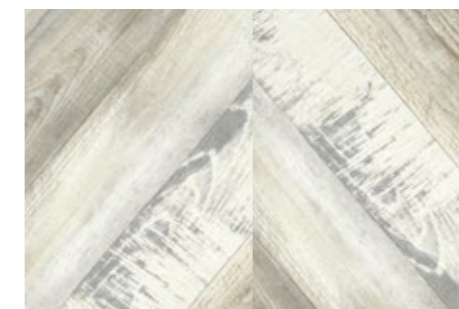

1161 Ungherese Bianco Vintage 30°
Emotion Finishing

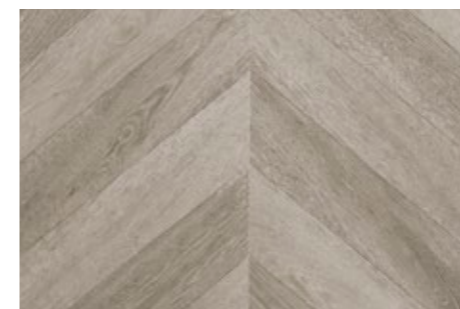

1162 Ungherese Rovere Smoked 45°
Emotion Finishing



Book Finiture
Finishing Book

Chateau Rovere Naturale Hydro Plus

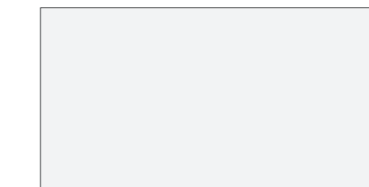

1183 x 601 x 8 mm

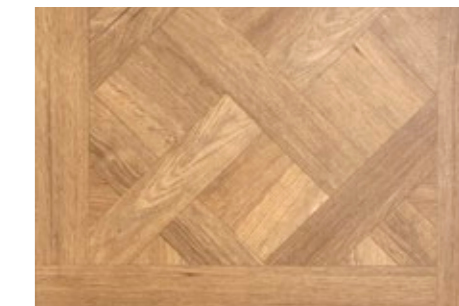

1164 Chateau Rovere Naturale
Emotion Finishing



PROTEZIONE
INCASTRO
WAX LOCK
PROTECTOR



SINCRO BISELLO
STAMPATO SUI 4 LATI
SYNCR BEVEL
PRINTED ON THE 4
SIDES



Bfl-s1 *



Adatto
Suitable



Antistatico
Antistatic



23



33





line Living PrestigeGoldHydro

Questa collezione negli anni si è affermata come un must have. Si presenta con una sempre più **ampia gamma** di decorativi, con tecnologia sincroporo e bisellato sui 4 lati, in grado di soddisfare qualsiasi tipo di necessità, dall'uso abitativo agli spazi commerciali. Oggi **Prestige Gold Hydro** si connota per le notevoli performance tecniche potenziate, grazie all'acquisizione della tecnologia **Hydro**, al salto di classe nella resistenza all'abrasione che passa ad **AC5** e nuovo incastro PLS.

This collection over the years has established itself as a must-have. It comes with an **ever-increasing range** of decors, with syncroporous technology and beveled on all 4 sides, capable of meeting all kinds of needs, from residential to commercial spaces. Today **Prestige Gold Hydro** is distinguished by its remarkable enhanced technical performance, thanks to the acquisition of **Hydro** technology, the class leap in abrasion resistance moving to **AC5** and new PLS interlocking.



INFO PRODOTTO
PRODUCT INFO

**Prestige Gold
Hydro
Quercia
Montana**

Prestige Gold Hydro

1288 x 198 x 8 mm

Info:

Incastro joint



Bisello bevel



Reazione al Fuoco *
Fire reaction *



Cfl-s1

Riscaldamento a pavimento
Suitable for radiant heating



Adatto
Suitable

Comportamento Elettrico
Static Electrical Behaviour



Antistatico
Antistatic

Idoneo ad ambienti umidi
Suitable For wet Environments



Domestico
Residential



23

Commerciale
Commercial



32

Resistenza all'abrasione
Abrasion resistance



Certificazioni / Certifications:



Accessori / Accessories:

Sottopavimenti
Underlayer Superior RBR + DB + ST

Profilo
Profile Kit Dislivello + Dilatazione + Terminale + Toro Scala Elite
Splice Kit + Expansion Kit + Terminal Kit + Elite Staire Nose

Battiscopa
Skirting Board Time + Look

Confezionamento / Packaging:

Rif. formato/Size	Pz/Pcs	m ²	Confezione/Box	m ²
1288x198	10	2,550	40	102,010

* Classificazione valida con l'utilizzo dei sottopavimenti e/o modalità indicate da Skema S.p.A. (per dettagli vedi scheda tecnica del prodotto e/o istruzioni per l'installazione).
* Classification valid with the use of underlayer and/or modality specified by Skema S.p.A. (please see product technical data sheet and/or installation instructions for details).

Prestige Gold Hydro



255 Rovere Giapponese
Emotion Finishing



256 Rovere Trentino
Emotion Finishing

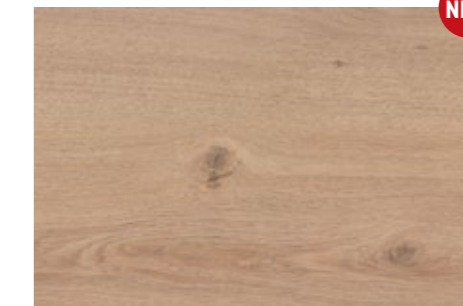

257 Quercia Montana
Emotion Finishing



258 Rovere Carbon
Emotion Finishing

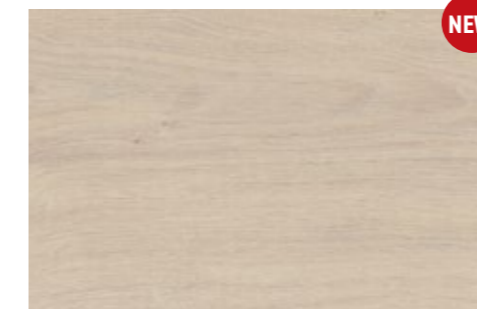

259 Rovere Comfort
Emotion Finishing

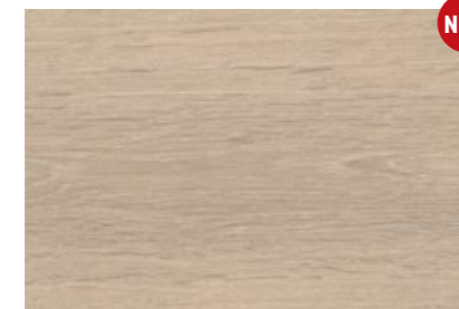

279 Hop Oak
Emotion Finishing

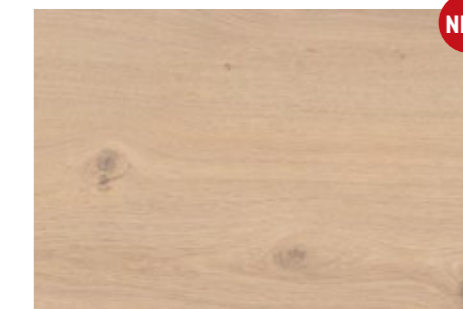

289 Rovere Francese
Emotion Finishing



292 Rovere Ischia New
Emotion Finishing



293 Rovere Ponza New
Emotion Finishing

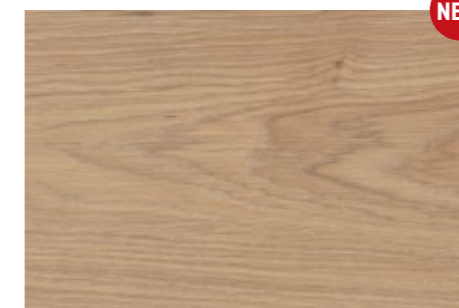

294 Rovere Linosa New
Emotion Finishing

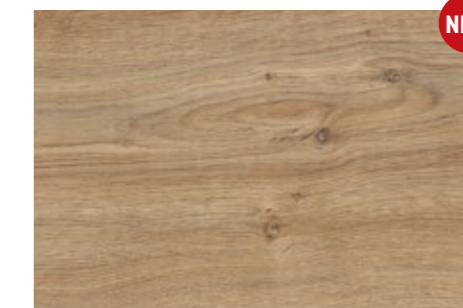

370 Sesame Oak
Emotion Finishing

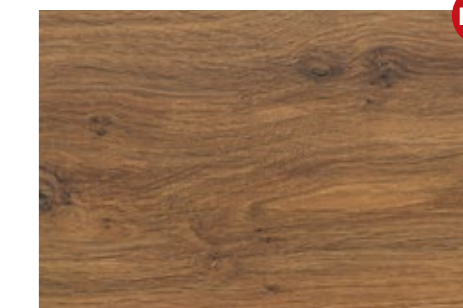

372 Pepper Oak
Emotion Finishing

Prestige Gold Hydro



139 Rovere Sole
Emotion Finishing



170 Rovere Zephir
Emotion Finishing



264 Quercia Naturale
Emotion Finishing



266 Rovere Positano
Emotion Finishing



Book Finiture
Finishing Book



Prestige Gold
Hydro
Hop Oak



line Living PrestigeLHydro

Prestige L Hydro è un grande classico tra i pavimenti in laminato Living di Skema che si presenta con il grande formato (2052x220 mm). Mantiene tutte le qualità che lo hanno fatto amare dal mercato: antistatico, bordi bisellati sui 4 lati e resa estetica naturale grazie alla tecnologia sincroporo. In più oggi si presenta anche con **tecnologia Hydro**, nuovo incastro **5G Dry** a tenuta stagna che impedisce ai liquidi di penetrare attraverso i profili e nuovi decorativi effetto zero gloss.

Prestige L Hydro is a great classic among Skema's Living laminate floors that comes in a large format (2052x220 mm). It retains all the qualities that have made it loved by the market: antistatic, beveled edges on 4 sides and natural aesthetic rendering thanks to syncroporous technology. In addition, today it also comes with **Hydro technology**, new watertight **5G Dry** interlocking that prevents liquids from penetrating through the profiles, and new zero-gloss effect decors.



INFO PRODOTTO
PRODUCT INFO

Prestige L
Hydro
Rovere
Apple

Prestige L Hydro - 5Gdry

2052 x 220 x 8 mm

Info:

Incastro joint		5G Dry NEW
Bisello bevel		
Reazione al Fuoco * Fire reaction *		Cfl-s1
Riscaldamento a pavimento Suitable for radiant heating		Adatto Suitable
Comportamento Elettrico Static Electrical Behaviour		Antistatico Antistatic
Idoneo ad ambienti umidi Suitable For wet Environments		
Domestico Residential		23
Commerciale Commercial		32
Resistenza all'abrasione Abrasion resistance		

* Classificazione valida con l'utilizzo dei sottopavimenti e/o modalità indicate da Skema S.p.A. (per dettagli vedi scheda tecnica del prodotto e/o istruzioni per l'installazione).
* Classification valid with the use of underlayer and/or modality specified by Skema S.p.A. (please see product technical data sheet and/or installation instructions for details).

Certificazioni / Certifications:



Accessori / Accessories:

Sottopavimenti Underlayer	Superior RBR + DB + ST
Profilo Profile	Kit Dislivello + Dilatazione + Terminale + Toro Scala Elite Splice Kit + Expansion Kit + Terminal Kit + Elite Staire Nose
Battiscopa Skirting Board	Time + Look

Confezionamento / Packaging:

Rif. formato/Size	Pz/Pcs	m ²	Confezione/Box	m ²
2052x220	6	2,708	36	97,511

Prestige L Hydro - 5Gdry



168 Grey Oak
Natural Finishing



178 Noce Autentico
Modern Finishing

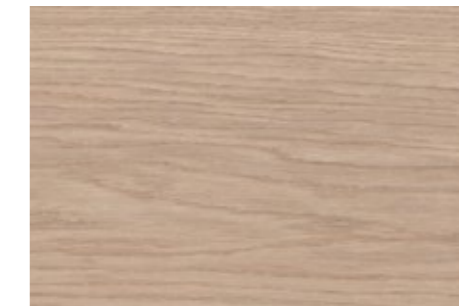

234 Rovere Apple
Natural Finishing



250 Rovere Senese
Natural Finishing



290 Alpaca Oak
Emotion Finishing



291 Eagle Oak
Emotion Finishing

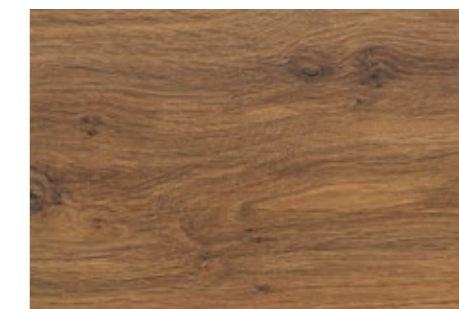

372 Pepper Oak
Emotion Finishing



Book Finiture
Finishing Book



line Living **Facile+**

Una collezione sempre attuale, perfetta in caso di ristrutturazioni veloci per trasformare in poco tempo l'aspetto di una casa, di un hotel o di un negozio. **Facile+** è un pavimento elegante e facile da posare che si caratterizza per l'assenza di bisellatura. Viene proposto con una varietà di decorativi sempre più ampia e di tendenza, anch'esso sfrutta le ultime tecnologie applicate ai laminati Skema per resistere meglio ai ristagni d'acqua.

An evergreen collection, perfect for quick renovations to transform the look of a house, hotel or store in no time. **Facile+** is an elegant and easy-to-install floor covering that features no beveling. It comes in an ever-increasing variety of trendy decors; it too takes advantage of the latest technologies applied to Skema laminates to better resist waterlogging.



INFO PRODOTTO
PRODUCT INFO

Facile+
Rovere
Tuscania

Facile+

1288 x 198 x 8 mm

Info:

Incastro joint



Bisello bevel

NO

Reazione al Fuoco *
Fire reaction *



Cfl-s1

Riscaldamento a pavimento
Suitable for radiant heating



Adatto
Suitable

Comportamento Elettrico
Static Electrical Behaviour



Antistatico
Antistatic

Idoneo ad ambienti umidi
Suitable For wet Environments



≤ 18 % (valore medio 9%)
≤ 18 % (average value 9%)

Domestico
Residential



23

Commerciale
Commercial



32

Resistenza all'abrasione
Abrasion resistance



* Classificazione valida con l'utilizzo dei sottopavimenti e/o modalità indicate da Skema S.p.A. (per dettagli vedi scheda tecnica del prodotto e/o istruzioni per l'installazione).
* Classification valid with the use of underlayer and/or modality specified by Skema S.p.A. (please see product technical data sheet and/or installation instructions for details).

Certificazioni / Certifications:



Accessori / Accessories:

Sottopavimenti
Underlayer

Superior RBR + DB + ST

Profilo
Profile

Kit Distivello + Dilatazione + Terminale
Splice Kit + Expansion Kit + Terminal Kit

Battiscopa
Skirting Board

Star + Time trendy + Look trendy

Confezionamento / Packaging:

Rif. formato/Size	Pz/Pcs	m ²	Confezione/Box	m ²
1288x198	10	2,550	40	102,010

Facile+



127 White Wood
Natural Finishing



128 Rovere Superior
Timber Finishing



166 Rovere Sunny
Natural Finishing

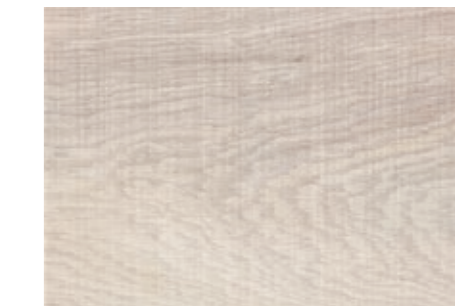

167 Rovere Crystal
Natural Finishing



168 Grey Oak
Natural Finishing

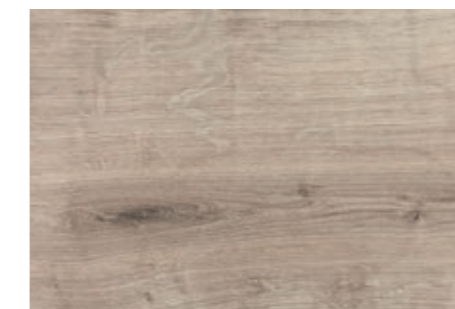

192 Rovere Luna
Natural Finishing



196 Rovere Umbro
Natural Finishing



242 Rovere Loira
Natural Finishing



250 Rovere Senese
Natural Finishing



252 Rovere Fiammingo
Timber Finishing



253 Rovere di Fiume
Emotion Finishing



254 Rovere Toscana
Emotion Finishing

Facile+



260 Grey Canyon
Natural Finishing



261 Sand Canyon
Natural Finishing



262 Black Canyon
Natural Finishing



280 Coffee Oak
Natural Finishing



Book Finiture
Finishing Book

* **ST** = STONALIZZATO / STONALIZED

Il decoro GREY OAK è stato progettato con importanti stonalizzazioni per renderlo naturale e con effetto anticato. Si consiglia di visionare almeno 4 doghe diverse di tono e le immagini disponibili nel Book Decorì in Area Download prima di procedere all'acquisto.

The GREY OAK decor is designed with important color variations to make it natural and with an antique effect. We suggest to view at least 4 planks in different tones and the images available in the "Book Decorì" in the Download Area before proceeding with the purchase.



Facile+
Grey Oak



line Living VisionOxidHydroPlus

La collezione **Vision Oxid Hydro Plus** si distingue per gli effetti materici, pietra, cemento e graniglia qui raccolti. Un design dallo stile moderno, con prestazioni eccezionali: massimo livello di classe di resistenza all'abrasione **AC6**, tecnologia **Hydro Plus** che lo protegge dai ristagni d'acqua per **24 ore**, e incastro tecnologico TLS.PF per una posa rapida e una tenuta stabile e precisa.

The **Vision Oxid Hydro Plus** collection is distinguished by the textural effects, stone, concrete, and grit collected here. A modern styled design with outstanding performance: highest level of abrasion resistance class **AC6**, **Hydro Plus** technology that protects it from water stagnation for **24 hours**, and TLS.PF technological interlocking for fast installation and stable and precise sealing.



INFO PRODOTTO
PRODUCT INFO

VisionOxid
HydroPlus
Graniglia
BiancoRomano

Vision Oxid Hydro Plus





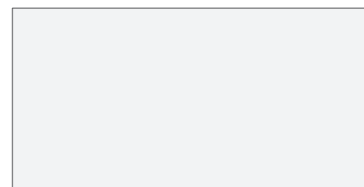

1183 x 396 x 8 mm MATT



1184 x 601 x 8 mm AUTHENTIC

Info:

Incastro joint		TLS.PF
Bisello bevel		SINCR0 BISELLO STAMPATO SUI 4 LATI SYNCR0 BEVEL PRINTED ON THE 4 SIDES
Reazione al Fuoco * Fire reaction *		Bfl-s1
Riscaldamento a pavimento Suitable for radiant heating		Adatto Suitable
Comportamento Elettrico Static Electrical Behaviour		Antistatico Antistatic
Idoneo ad ambienti umidi Suitable For wet Environments		
Domestico Residential		23
Commerciale Commercial		33
Resistenza all'abrasione Abrasion resistance		

* Classificazione valida con l'utilizzo dei sottopavimenti e/o modalità indicate da Skema S.p.A. (per dettagli vedi scheda tecnica del prodotto e/o istruzioni per l'installazione).
* Classification valid with the use of underlayer and/or modality specified by Skema S.p.A. (please see product technical data sheet and/or installation instructions for details).

Certificazioni / Certifications:



Accessori / Accessories:

Sottopavimenti Underlayer	Superior RBR + DB + ST
Profilo Profile	Kit Distivello + Dilatazione + Terminale Splice Kit + Expansion Kit + Terminal Kit
Battiscopa Skirting Board	Time Trendy + Look Trendy

Confezionamento / Packaging:

Rif. formato/Size	Pz/Pcs	m ²	Confezione/Box	m ²
1183x396	5	2,340	42	98,295
1184x601	3	2,135	68	145,163

Vision Oxid Hydro Plus

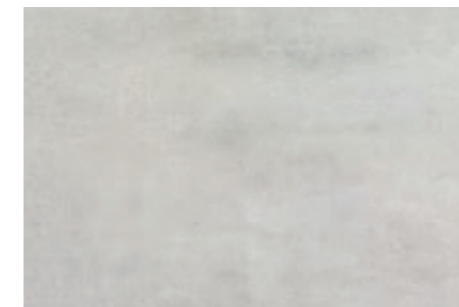

1122 Warm Gray
Matt Finishing



1170 Cemento Spatolato
Authentic Finishing

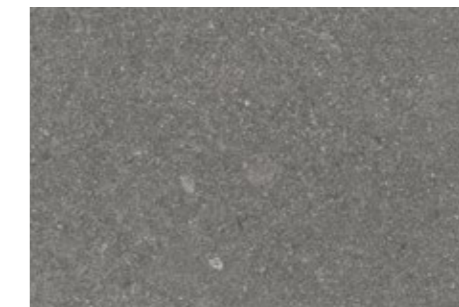

1172 Graniglia Bardiglio
Authentic Finishing



1173 Graniglia Carrara
Authentic Finishing

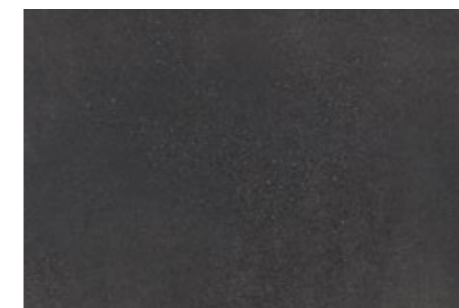

1174 Graniglia Marquina
Authentic Finishing

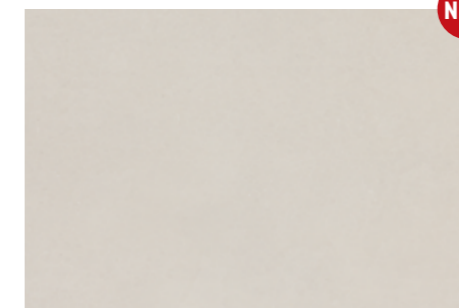

1176 Graniglia Bianco Romano
Authentic Finishing

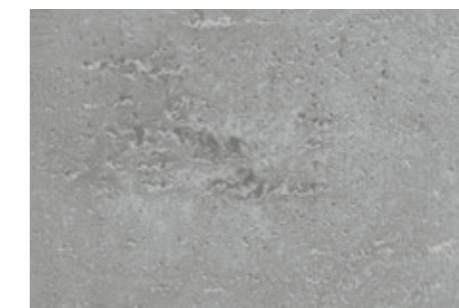

3275 Cemento Grezzo
Authentic Finishing



Book Finiture
Finishing Book



INFO PRODOTTO
PRODUCT INFO

VisionTechnic
Hydro
Acciaio
Brunito

NEW line Living
VisionTechnicHydro

La collezione di laminati con decori che riproducono gli effetti acciaio e pietra **Vision Technic Hydro** è pensato in particolare per il **settore allestitivo, contract e office**, intercettando tutte le richieste tipiche di questi ambienti: facilità e rapidità di posa, resistenza all'abrasione e resistenza al calpestio, sicurezza, resistenza al fuoco, estetica contemporanea e formato accattivante (853x395x8 mm).

The collection of laminates with decors that reproduce the steel and stone effects **Vision Technic Hydro** is designed especially for the **exhibition, contract and office sectors**, intercepting all the typical demands of these environments: ease and speed of installation, abrasion resistance and resistance to trampling, safety, fire resistance, contemporary aesthetics and attractive format (853x395x8 mm).

Vision Technic Hydro NEW



857 x 398 x 8 mm

Info:

Incastro
joint



Bisello
bevel



Reazione al Fuoco *
Fire reaction *



Cfl-s1

Riscaldamento a pavimento
Suitable for radiant heating



Adatto
Suitable

Comportamento Elettrico
Static Electrical Behaviour



Antistatico
Antistatic

Idoneo ad ambienti umidi
Suitable For wet Environments



Domestico
Residential



23

Commerciale
Commercial



32

Resistenza all'abrasione
Abrasion resistance



* Classificazione valida con l'utilizzo dei sottopavimenti e/o modalità indicate da Skema S.p.A. (per dettagli vedi scheda tecnica del prodotto e/o istruzioni per l'installazione).

* Classification valid with the use of underlayer and/or modality specified by Skema S.p.A. (please see product technical data sheet and/or installation instructions for details).

Certificazioni / Certifications:



Accessori / Accessories:

Sottopavimenti
Underlayer Superior RBR + DB + ST

Profilo
Profile Kit Dislivello + Dilatazione + Terminale
Splice Kit + Expansion Kit + Terminal Kit

Battiscopa
Skirting Board Time Trendy + Look + Look Trendy

Confezionamento / Packaging:

Rif. formato/Size	Pz/Pcs	m ²	Confezione/Box	m ²
857x398	7	2,387	30	71,610

Vision Technic Hydro NEW

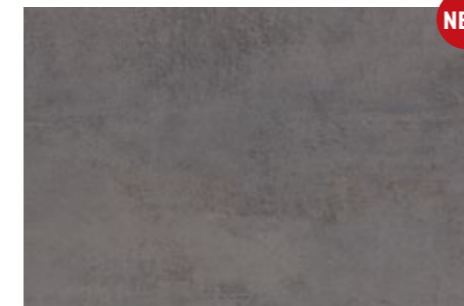

205 Acciaio Brunito
Stone Finishing

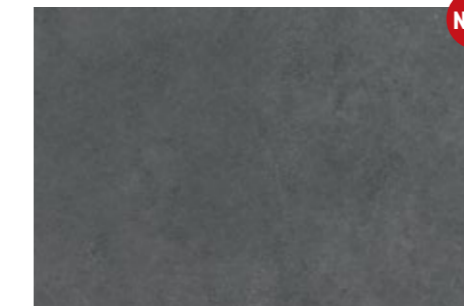

206 Pietra Portoghese
Stone Finishing



207 Pietra Carnica
Stone Finishing



208 Pietra D'istria
Stone Finishing



Living**Accessori**

Oltre a fornirvi un pavimento di effetto, Skema propone una ricca gamma di accessori che vanno a completare l'opera con soluzioni di grande impatto visivo. Un pavimento nuovo significa una soluzione completa, in cui accessori coordinati quali profili scala, battiscopa, giunti di dilatazione e profili angolari contribuiscono a creare un ambiente bello e armonioso in cui vivere. E' per questo motivo che Skema ha studiato linee di accessori coordinati oppure abbinati per tutte le collezioni Skema.

Skema provides you with an impressive flooring and a wide range of accessories to complete the work with solutions of striking visual impact. A new flooring provides a complete solution with accessories, such as matching stair noses, skirting boards, expansion joints and L-shaped profiles, that contribute to create a pleasant and harmonious living environment. Precisely for this reason, Skema designed accessory lines that can be matched or combined with all Skema collections.



PRODOTTO - PRODUCT	DIMENSIONE - SIZE	DESCRIZIONE - DESCRIPTION
<p>SUPERIOR RBR SUPERIOR RBR</p> 	<p>1000 mm</p>	<p>Sottopavimento dalle performance elevate costituito da un'alta percentuale di cariche minerali unite da legante poliuretano, con densità media di 800 kg/m³, soddisfa ampiamente lo standard EPLF emanato per i sottopavimenti. In particolare SUPERIOR RBR ha ottima resistenza meccanica CS che protegge l'incastro, ha elevate caratteristiche acustiche IS, in particolare per la riduzione del riverbero del rumore in stanza RWS e bassa resistenza termica TR essendo così fortemente consigliato per la posa su massetti radianti; Superior RBR è integrato da una barriera vapore (PET/alluminio) ed è infine un prodotto che non contiene sostanze pericolose ed è a bassissima emissione di composti organici volatili (COV). Posare il lato in PET/alluminio verso l'alto. Vedi scheda tecnica per la descrizione tecnica completa.</p> <p>High-performance underlay made with a high percentage of mineral fillers combined with polyurethane binder, with an average density of 800 kg/m³, which largely meets the EPLF standard issued for underlays. In particular, SUPERIOR RBR has an excellent CS mechanical resistance that protects the joint, elevated IS acoustic characteristics, in particular for the reduction of noise reverberation in the RWS room and low TR thermal resistance, making it so strongly recommended for installation on radiant subfloors; Superior RBR is equipped with a vapour barrier (PET/aluminium) and it is a product that does not contain dangerous substances, having also a very low emission of volatile organic compounds (VOC). Lay the PET/aluminium side upwards. See technical data sheet for full technical description.</p>

<p>BARRIERA A VAPORE BN BN MOISTURE BARRIER</p> 	<p>1200 mm - 100 µm</p>	<p>Foglio di polietilene coestruso, spessore 100 micron, densità 0,93 g/cm³.</p> <p>Coextruded polyethylene film, 100 micron thickness, density 0.93 g/cm³.</p>
---	-------------------------	---

PRODOTTO - PRODUCT	DIMENSIONE - SIZE	DESCRIZIONE - DESCRIPTION
<p>SOTTOPAVIMENTO DB DB UNDERLAYER</p> 	<p>1000 - 2 mm</p>	<p>Sottopavimento dalle performance medie costituito da una schiuma poliolefinica a celle chiuse estrusa in modalità controllata con densità media di 80 kg/m³. DB soddisfa lo standard EPLF emanato per i sottopavimenti. In particolare DB ha buone performance di resistenza meccanica CS, ha buon isolamento al rumore da calpestio IS ed è integrato da una barriera vapore SD (PET) che evita la diffusione dell'umidità dal sottofondo al pavimento ed è dotato di una cimosa laterale con nastro adesivo preapplicato per la congiunzione dei materassini. DB è prodotto senza CFC (clorofluorocarburi) e HCFC (idrofluorocarburi) e non contiene né plastificanti né metalli pesanti o altre sostanze pericolose. Posare il lato nero con la barriera vapore rivolto verso l'alto. Vedi scheda tecnica per la descrizione completa delle caratteristiche.</p> <p>Underlay with average performance made with a closed-cell polyolefin foam extruded in controlled mode with an average density of 80 kg/m³. DB meets the EPLF standard issued for underlays. In particular, it has good CS mechanical resistance performance, good IS insulation against footsteps noise and is supplemented by an SD (PET) vapour barrier that prevents the diffusion of moisture from the subfloor to the floor and is equipped with a side selvedge with pre-applied adhesive tape to join the underlay. DB is produced without CFCs (chlorofluorocarbons) and HCFCs (hydrofluorocarbons) and does not contain plasticizers, heavy metals or other dangerous substances. Lay the black side with the vapour barrier facing upwards. See data sheet for full description of the characteristics.</p>
<p>SOTTOPAVIMENTO ST ST UNDERLAYER</p> 	<p>1000 - 2 mm</p>	<p>Sottopavimento dalle performance standard costituito da una schiuma poliolefinica a celle chiuse estrusa in modalità controllata con densità media di 20 kg/m³. ST soddisfa lo standard EPLF emanato per i sottopavimenti. In particolare ST ha performance di resistenza meccanica CS adatte all'utilizzo con sistemi di posa tipo "click", ha buon isolamento al rumore da calpestio IS ed è integrato da una barriera vapore SD (PET/alluminio) che evita la diffusione dell'umidità dal sottofondo al pavimento. ST è prodotto senza CFC (clorofluorocarburi) e HCFC (idrofluorocarburi) e non contiene né plastificanti né metalli pesanti o altre sostanze pericolose. Posare il lato metallizzato alluminio verso l'alto. Vedi scheda tecnica per la descrizione completa delle caratteristiche.</p> <p>Standard performance underlay made with closed-cell polyolefin foam extruded in controlled mode with an average density of 20 kg/m³. ST meets the EPLF standard issued for underlays. In particular, ST has CS mechanical resistance performance suitable for use with "click" type laying systems, has good insulation against IS footsteps noise and is equipped with an SD (PET/aluminium) vapour barrier that prevents the diffusion of moisture from the substrate to the floor. ST is produced without CFCs (chlorofluorocarbons) and HCFCs (hydrofluorocarbons) and contains neither plasticizers nor heavy metals or other dangerous substances. Lay the metallised aluminium side upwards. See technical data sheet for full description of features.</p>

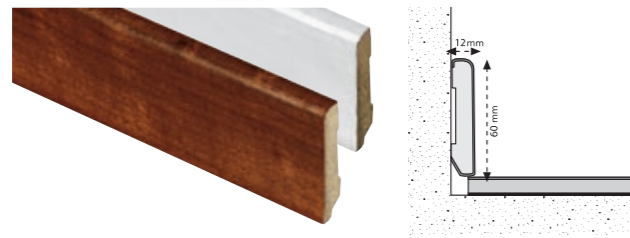
PRODOTTO - PRODUCT	DIMENSIONE - SIZE	DESCRIZIONE - DESCRIPTION
<p>BATTISCOPA STAR STAR SKIRTING BOARD</p> 	<p>H 60 2400x60x12 mm</p>	<p>Questo profilo battiscopa è in HDF. Le sue proporzioni standard (60 mm di altezza per 12 mm di base) lo rendono ideale per la finitura perimetrale del pavimento in locali piccoli e nelle abitazioni in genere.</p> <p>This skirting profile is made of HDF. Its standard proportions (60 mm high by 12 mm base) make it ideal for perimeter floor finishing in small rooms and in homes in general.</p>
<p>BATTISCOPA TIME TIME SKIRTING BOARD</p> 	<p>H 80 2400x80x14 mm</p>	<p>Questo profilo battiscopa è in HDF con decorativi di tendenza. E' consigliabile l'uso in locali di ampia dimensione, sia per l'impatto estetico (è caratterizzato infatti da una maggiore altezza - 80 mm) che per la funzionalità (la base leggermente più ampia - 14 mm consente di lasciare più spazio ai bordi, tra il pavimento e la parete).</p> <p>HDF skirting board with trendy modern design decors and pore finishing. It is suitable for large environments for its aesthetic impact (80 mm of height) and functionality (the thickness of 14 mm allows more dilatation space between floors and walls).</p>
<p>BATTISCOPA LOOK LOOK SKIRTING BOARD</p> 	<p>H 45 2200x45x14 mm 2400x45x14 mm</p>	<p>Questo profilo battiscopa è in HDF con decorativi di tendenza dal design moderno e finitura poro. E' studiato per ambienti sia pubblici che privati che richiedano la massima resa estetica e prestazionale, è caratterizzato infatti da una altezza inferiore, 45 mm per 14 mm di base.</p> <p>HDF skirting board with trendy modern design and pore finishing. It's developed for both public and private environments requiring the maximum aesthetic and technical performance. It's in fact characterized by a lower height of 45 mm and base of 14 mm.</p> <p>* la dimensione 2200 mm viene fornita fino ad esaurimento scorte * the 2200 mm size is supplied while stock lasts</p>

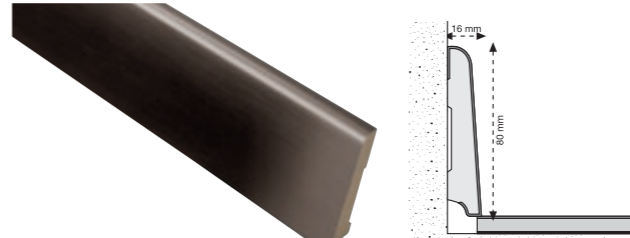

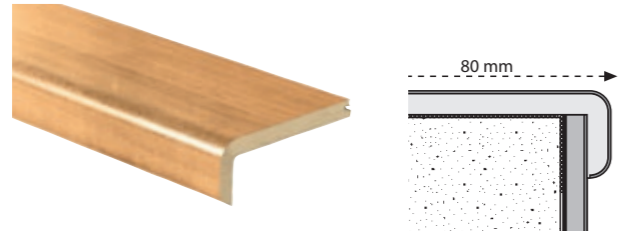
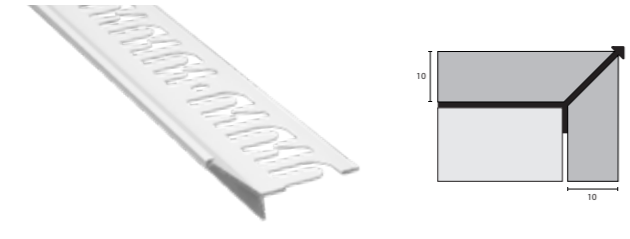
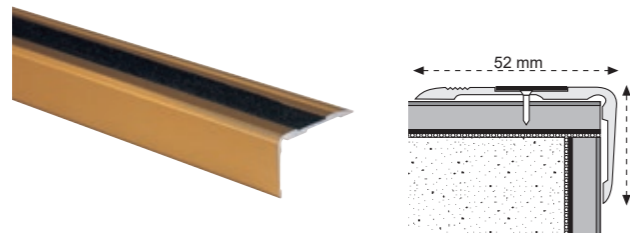
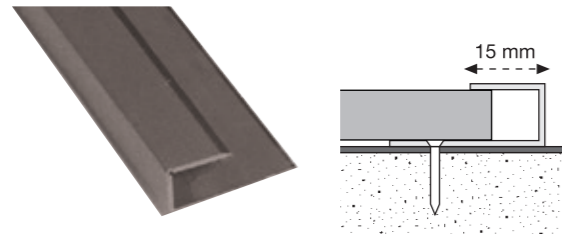

PRODOTTO - PRODUCT	DIMENSIONE - SIZE	DESCRIZIONE - DESCRIPTION
<p>BATTISCOPA DROP DROP SKIRTING BOARD</p> 	<p>H 70 2400x70x15 mm</p>	<p>Questo profilo battiscopa è in HDF a basso assorbimento con decorativi di tendenza e finitura poro. Grazie anche alla sua particolare densità (700 kg/mc) dimostra un'elevata resistenza all'umidità. L'altezza intermedia di 70 mm ne consente l'uso in ambienti di ogni dimensione.</p> <p>This skirting board is made of low absorption HDF with trendy decors and pore finishing. Thanks also to its particular density (700 kg/mc) demonstrates high moisture resistance. The average height of 70 mm allows it to be used in rooms of every dimensions.</p>
<p>BATTISCOPA TREND METAL * TREND SKIRTING BOARD METAL *</p> 	<p>H 80 2200x80x16 mm</p>	<p>Il battiscopa Trend - Metal (80 mm di altezza per 16 mm. di base) è realizzato con decorativi metallici, ideale per abbinamenti ai pavimenti dal design moderno e raffinato.</p> <p>The Trend - Metal skirting board (80 mm of height and 16 mm of base) is available in metal decors matching with the design floorings.</p>

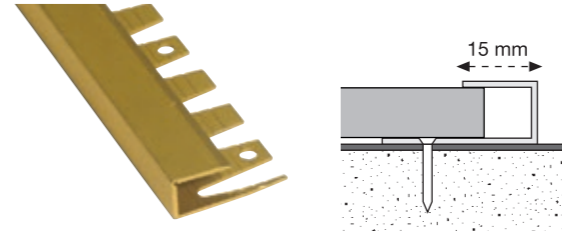
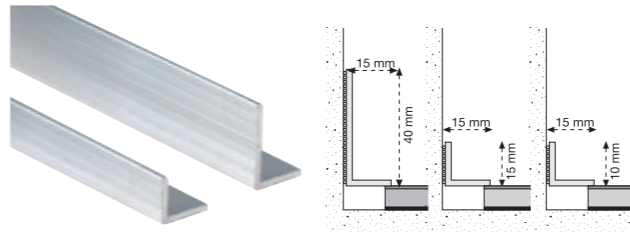
* PRODOTTO IN ELIMINAZIONE / DISMISSING ITEM

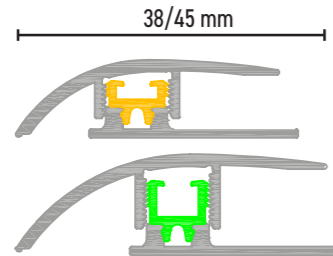
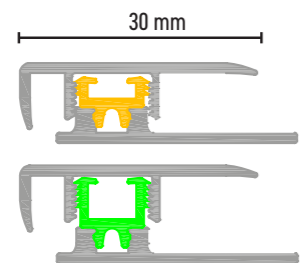
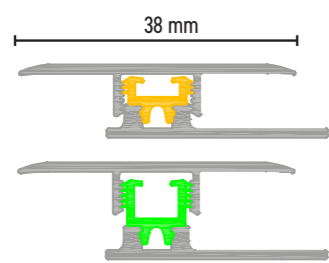
PRODOTTO - PRODUCT	DIMENSIONE - SIZE	DESCRIZIONE - DESCRIPTION
<p>TORO SCALA ELITE ELITE STAIR NOSE</p> 	2430x80x30 mm	<p>Per pavimenti collezione Prestige Gold Hydro E Prestige L Hydro e K-uno Hydro Plus (sp. 8-10 mm). Questo toro scala è in HDF con decorativo abbinato legno. Viene utilizzato a completamento della finitura delle scale rivestite con pavimento laminato. Da accoppiare esclusivamente con la maschiatura sul lato lungo dei pavimenti. AVVERTENZA: Fissare con specifico collante.</p> <p>For Prestige Gold Hydro, Prestige L Hydro e K-uno Hydro Plus l collection floor (8-10 mm thickness) HDF stair profile available in wood-like decors, used for the finishing of stairs. Only fitting with the tongue on the long side of the planks. WARNING: fix it with specific glue.</p>
<p>PROFILO SCALA 45 GRADI 45 DEGREE STAIR PROFILE</p> 	3000x10 mm	<p>Profilo paragrado in alluminio anodizzato argento a protezione degli angoli esterni di rivestimenti o pavimenti; la forma arrotondata funge anche da finitura simmetrica ed antinfortunistica dell'angolo del rivestimento.</p> <p>Silver anodized aluminium stair profile to protect the external corners of claddings or floors; the rounded edge is used also as a symmetrical and accident preventing finish for the corner of the cladding.</p>
<p>PARAGRADINO ANTISDRUCCIOLO IN ALLUMINIO NO-SLIP STAIR PROTECTOR</p> 	3400x52x30 mm	<p>Consigliato per ambienti pubblici e commerciali, consente di rivestire il raccordo tra alzata e pedata di una scala con una superficie antiscivolo. Acquistare sempre paragrado metallico più antiscivolo autoadesivo.</p> <p>Recommended for public and commercial areas. It allows you to cover the space between the riser and the tread of a stair with a non-slip surface. Always purchase the metal stair guard together with the self-adhesive non slip strip.</p>
<p>PROFILO DI BORDO BORDER PROFILE</p> 	2700x15x9 mm 2700x15x11 mm	<p>Profilo in alluminio estruso per bordature perimetrali per pavimenti.</p> <p>Extruded aluminium profile for perimeter edging for floorings.</p>

PRODOTTO - PRODUCT	DIMENSIONE - SIZE	DESCRIZIONE - DESCRIPTION
<p>PROFILO DI BORDO CURVABILE CURVABLE BORDER PROFILE</p> 	2700x15x9 mm 2700x15x11 mm 2700x15x13 mm	<p>Profilo in alluminio estruso curvabile per bordature perimetrali.</p> <p>Extruded curvable aluminium profile for perimeter edging.</p>
<p>ANGOLARE AD L IN ALLUMINIO L-SHAPED ALUMINIUM CORNER ELEMENT</p> 	2000/3000x15x10 mm 1988/2000x15x15 mm 1988/2000x15x40 mm	<p>Profilo in alluminio per la finitura di raccordi a muro. Disponibile con altezza di 40 mm, 15 mm e 10 mm.</p> <p>Aluminium profile for finishing the connections with walls. Available in 40 mm, 15 mm and 10 mm heights.</p>

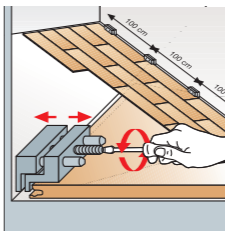
PRODOTTO - PRODUCT	DIMENSIONE - SIZE	SPESSORE PAVIMENTO THICK FLOORING	DESCRIZIONE - DESCRIPTION
KIT DISLIVELLO DA 6 A 12,5 mm SPLICE KIT FROM 6 TO 12,5 MM		6 > 9,5 mm	Kit dislivello in alluminio con Pin Unico per pavimenti con spessore da 6 a 12,5 mm con base femmina in alluminio.
		9 > 12,5 mm	Aluminum splice kit with Single Pin for floorings with thickness from 6 to 12,5 mm and aluminum female base.
KIT TERMINALE DA 6 A 12,5 mm TERMINAL KIT FROM 6 TO 12,5 MM		6 > 9,5 mm	Kit terminale in alluminio con Pin Unico per pavimenti con spessore da 6 a 12,5 mm, con base femmina in alluminio.
		9 > 12,5 mm	Aluminum terminal kit with Single Pin for floorings with thickness from 6 to 12,5 mm and aluminum female base.
KIT DILATAZIONE DA 6 A 12,5 mm EXPANSION KIT FROM 6 TO 12,5 MM		6 > 9,5 mm	Kit dilatazione in alluminio con Pin Unico per pavimenti con spessore da 6 a 12,5 mm, con base femmina in alluminio.
		9 > 12,5 mm	Aluminum expansion kit with Single Pin for floorings with thickness from 6 to 12,5 mm and aluminum female base.

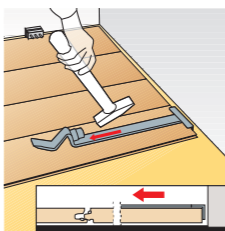
PRODOTTO - PRODUCT	DESCRIZIONE - DESCRIPTION
 <p>COLLA NUNIVIL 1008 (D3) GLUE NUNIVIL 1008 (D3)</p>	<p>Adesivo acetovinilico speciale indicato per incollaggio dei pavimenti flottanti con incastro M/F. Per il corretto utilizzo consultare la documentazione tecnica. Consumo medio indicativo di colla: 35/40 gr/mq</p> <p>Special PVA glue for wet-resistant gluing specific for the installation flooring with T&G joint, where the adhesive acts also as sealant. For the right use, please read the technical information. Estimated average glue consumption: 35/40 gr/m².</p>
 <p>COLLA ISOCOLL ECO 6056 BIANCO PER SCALE BATTISCOPA GLUE ISOCOLL ECO 6056 WHITE FOR STEPS AND SKIRTING BOARDS</p>	<p>Colla monocomponente per il fissaggio del battiscopa e incollaggio gradini.</p> <p>Single component adhesive for fastening skirting and stair elements.</p>
 <p>KIT MORSETTI TELESCOPICI TELESCOPIC CLAMP KIT</p>	 <p>In fase di partenza il muro non è mai regolare. I morsetti permettono di registrare la distanza tra muro e pavimento in senso longitudinale, accelerando le fasi di posa di un pavimento flottante. Consigliati 2 kit per posatore.</p> <p>When starting, walls are never perfect. These clamps allow you to register the horizontal distance between the wall and the flooring, for more rapid installation. 2 kits per installer are recommended</p>
 <p>GRIMALDELLO PICKLOCK</p>	 <p>È indispensabile per completare l'ultima fila di pavimento, in quanto non c'è spazio per la manovra del martello. Solo per incastri SLS e PLS (no TLS). Consigliato 1 pezzo per posatore.</p> <p>This tool is required for finishing the last row of the flooring as there is no place enough for using the hammer. We recommend 1 tool per installer.</p>

PRODOTTO - PRODUCT **DESCRIZIONE - DESCRIPTION**

DISTANZIATORE PERPAVIMENTI AV2
AV2 SPACER FOR FLOORING

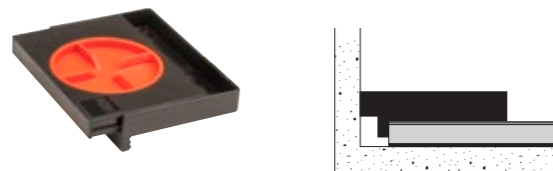

Pratico distanziatore in materiale plastico per la posa di pavimenti flottanti. Regolazione 5-20 mm.

Handy spacer for floating floorings installation. Regulation range 5 to 20 mm.

DISTANZIATORE PER PAVIMENTI FLOTTANTI
SPACER FOR FLOATING FLOORING

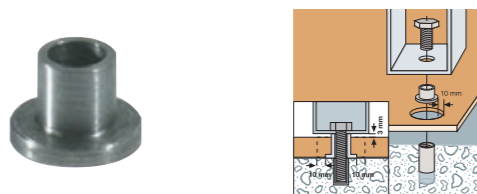

Nei casi in cui si debba fissare al pavimento elementi di arredo o funzionali, consente di evitare il bloccaggio delle dilatazioni del pavimento e conseguenti sollevamenti dello stesso.

If you need to fasten pieces of furniture or functional elements to the flooring, it avoids blocking the flooring expansion and its consequent raising.

TENSIONATORE A CINGHIA
BELT TENSIONER

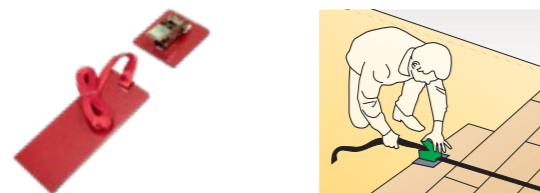

Per pavimenti con incastro a colla. Strumento per compattare le prime tre/quattro file di doghe, fondamentali per la buona riuscita del lavoro soprattutto con colori chiari su incastri tradizionali a colla. Consigliati 6 pezzi per posatore.

For floorings with glued joints. Used to compact the first three or four rows of planks. Fundamental for good installation, especially for light colours with traditional glued joints. 6 units per installer are recommended.

BATTITAVOLA PAVIMENTI LAMINATI
STAVES ALIGNER

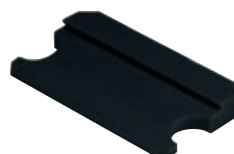

Indispensabile per raccordare le doghe. Consigliato 1 pezzo per posatore. Avvertenza: Usare esclusivamente battitavola originali per evitare di danneggiare l'incastro in modo irreparabile.

Indispensable for aligning the edge of the panels. We recommend 1 tool per installer. Notice: Use only original Staves Aligner to avoid irreparable damages to the joint.

ACCESSORI DI MONTAGGIO COMPLEMENTARI
COMPLEMENTARY INSTALLATION ACCESSORIES



Accessori utili per un lavoro preciso e veloce.

Accessories for accurate, rapid installation.

PRODOTTO - PRODUCT **DESCRIZIONE - DESCRIPTION**

PRODOTTI PER PULIZIA, IGIENIZZAZIONE E DECONTAMINAZIONE
CLEANING, SANITIZATION AND DECONTAMINATION PRODUCTS



Dedicati ai pavimenti Sistema Living e Sintesy.

Dedicated to Sistema Living and Sintesy floors.

NELLA SEZIONE TECNICA DELL'AREA DOWNLOAD DEL SITO SONO DISPONIBILI I MANUALI DI PULIZIA E MAUNTENZE. / CLEANING AND MAUNTENANCE MANUALS ARE AVAILABLE IN THE TECHNICAL SECTION OF THE DOWNLOAD AREA OF THE WEBSITE.

Accessori per posa a parete_Accessories for wall laying

PRODOTTO - PRODUCT	DIMENSIONE - SIZE	DESCRIZIONE - DESCRIPTION
<p>CLIP DI AGGANCIO RETAINING CLIPS</p> 	<p>44x41 mm Confezione / Packaging 200 pz / pcs</p>	<p>La clip di aggancio zincata nera è l'elemento metallico che incastrandosi per rotazione sull'omega fissa il pannello e le doghe alla struttura. Per K-uno Hydro Plus, Prestige L Hydro e Lumbertech. The black galvanized attachment clip is a metal piece that clips onto the omega strip by rotation and fastens the panels to the supporting structure. For K-uno Hydro Plus, Prestige L Hydro and Lumbertech.</p>
<p>PROFILO OMEGA OMEGA PROFILE</p> 	<p>3000x25x26 mm 3000x13x26 mm * Confezione / Packaging 1pz / pcs</p>	<p>Il profilo ad omega costituisce l'elemento per il fissaggio a parete, tramite viti o tasselli deve essere montato ad una struttura portante tipo cartongesso o al muro da rivestire. Omega cross-section profile is the element that fastens the boards to the wall. It must be installed using screws or wall plugs to a load bearing structure, such as drywall or the wall to be covered.</p>

* Questo profilo omega a spessore ridotto 13 mm non è compatibile con i prodotti fonoassorbenti in quanto non c'è lo spazio sufficiente per l'inserimento del materassino da 20 mm.

* This Omega profile with reduced thickness of 13 mm is not suitable with sound-absorbing products since there is not enough space for placing the 20 mm pad.

Tabella Logistica _Logistics Data Table

	Dimensioni Dimension	doghe per confezione Pcs/Box	Superficie mq per confezione* Sqm per box*	Dimensioni confezione Box dimensions	Peso per confezione Box Weight	Confezione per pallet Boxes per pallet	Superficie mq per pallet* Sqm per pallet*	Dimensione pallet quando intero Pallet dimensions	Peso al mq Weight per sqm	Peso lordo pallet Pallet Weight
	mm	n	mq sqm	mm	kg	n	mq sqm	mm	kg	kg
LIVING										
K.UNO HYDRO PLUS	2052x248x10	4	2,035	2070x260x40	18,380	42	85,494	2110x830x750	9,03	787
SYNCR0 PARQUET HYDRO PLUS UNGHERESE	1184x293x8	6	2,081	1210x305x50	16,140	51	106,300	1220x930x1000	7,75	839
SYNCR0 PARQUET HYDRO PLUS CLASSICA	1182x293x8	6	2,078	1210x305x50	17,080	51	106,020	1220x930x1000	8,22	886
SYNCR0 PARQUET HYDRO PLUS CHATEAU	1183x601x8	3	2,132	1210x610x25	18,320	68	145,040	1220x1230x1030	8,59	1261
PRESTIGE GOLD HYDRO	1288x198x8	10	2,550	1302x210x80	18,90	40	102,010	1305x850x960	7,40	770
PRESTIGE L HYDRO	2052x220x8	6	2,708	2069x236x48	20,120	36	97,511	2120x930x585	7,43	740
FACILE+	1288x198x8	10	2,550	1302x210x80	18,440	40	102,010	1305x850x960	7,23	753
VISION OXID HYDRO PLUS (MATT)	1183x396x8	5	2,340	1210x405x45	19,820	42	98,295	1220x830x1020	8,46	848
VISION OXID HYDRO PLUS (AUTHENTIC)	1184x601x8	3	2,135	1210x610x25	17,020	68	145,163	1220x1230x1030	7,98	1172
VISION TECHNIC HYDRO	857x398x8	7	2,387	870x410x55	17,65	30	71,610	1240x880x700	7,40	546

I valori espressi sono calcolati considerando i decimi di millimetro / The values indicated are calculated considering the tenths of a millimeter.

I dati tecnici possono subire modifiche senza obbligo di preavviso / Technical details may be changed without any previous warning

ATTENZIONE, le tonalità dei decori qui riprodotte e le campionature esposte sono da considerarsi puramente indicative a causa delle caratteristiche intrinseche o delle variabilità del prodotto naturale utilizzato. I dati tecnici possono subire modifiche senza obbligo di preavviso. Per ulteriori informazioni o dati tecnici contattare il nostro ufficio tecnico, oppure visitare il sito www.skema.eu.

ATTENTION, the decors presented here in and samples available are to be considered merely as indicative due to the variable natural characteristics of the products used. Technical details may be modified without any prior warning. For further information or other technical details, please contact Skema technical office or visit www.skema.eu.



SKEMA®



SKEMA S.p.A.

ITALY

T +39 0422 858511

skema.eu - info@skema.eu